

Installation guide

XS4 Reader

Eng Card reader installation guide

- E** Guía de instalación lector de tarjetas
- D** Kartenleser installationsanleitung
- F** Guide d'installation lecteur de cartes
- NL** Kaartlezer Installatiehandleiding
- SVE** Kortläsare installationsguide

WRDx0E4x
WRDx0S4x
WRDx0E4xK
WRDx0s4xK series

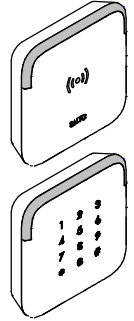
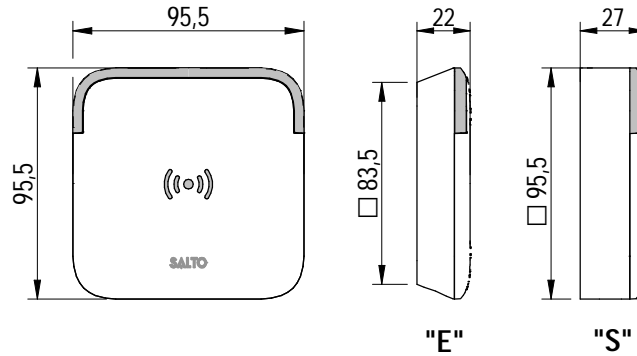
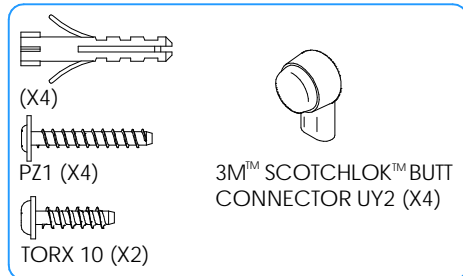

Eng Installation **E** Instalación **D** Installation **F** Installation **NL** Installatie **SVE** Installation

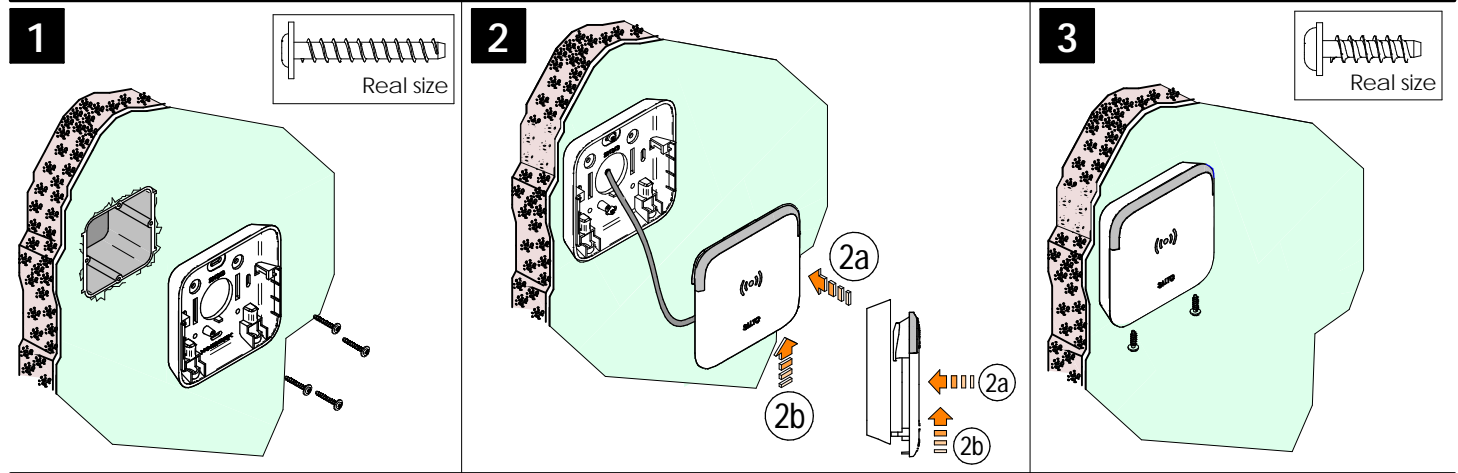

- Eng** Gang electrical standard box
E Módulo caja eléctrica estándar
D Standard schalterdose
F Plots d'encastrement standard
NL Standaard elektrische inbouwdoos
SVE Standard apparatlada

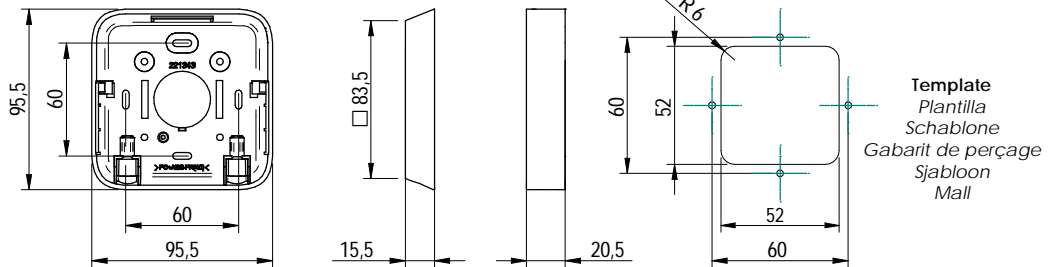

UL Statements *

Tested by UL with Mifare (DESFIRE, ULTRALIGHT C) and HID iCLASS RFID communication, and with Mobile APP (JustIN Mobile version 2.x) through Bluetooth version 4.2. Minimum Operating System version for Android: 4.3 or later and for iOS: 10.0 or later. A means of verification shall be employed by the user to enable access to the wireless electronic device such as a PIN or biometric feature. The wireless electronic device is not capable of command, control, programming, or any other system manipulation and it is only to be used in the same manner as a physical credential. Wiring methods that shall be in accordance with the National Electrical Code, ANSI/NFPA 70 or CSA C22.1-02 - Canadian Electrical Code, Part 1, Safety Standard for Electrical Installations

- UL294 performance level:

FEATURE	LEVEL
Destructive attack	I
Line Security	I
Endurance	IV
Standby power	Per rating of the power supply

- Comply with ULC-S319 Class I

This device complies with Industry Canada license-exempt RSS standard(s). Operation is subject to the following two conditions: (1) this device may not cause harmful interference, and (2) this device must accept any interference received, including interference that may cause undesired operation. Changes or modifications not expressly approved by the party responsible for compliance could void the user's authority to operate the equipment.

Le présent appareil est conforme aux CNR d'Industrie Canada applicables aux appareils radio exempts de licence. L'exploitation est autorisée aux deux conditions suivantes: (1) l'appareil ne doit pas produire de brouillage, et (2) l'utilisateur de l'appareil doit accepter tout brouillage radioélectrique subi, même si le brouillage est susceptible d'en compromettre le fonctionnement.

This device has been tested and found to comply with the limits for a Class B digital device, pursuant to ICES-003.



Installation guide

XS4 Reader

Eng Electrical characteristics

Operation conditions

	Min.	Max.	Unit
Temperature WRDOB - WRDOBK	-35	+66	°C
	-31	+150	°F
Temperature WRDOJ - WRDOGK - WRDOJK	-25	+66	°C
	-13	+150	°F
Humidity	35	85	%

RF characteristics

	Min	Gen.	Max	Unit
RFID frequency		13.56		Mhz
Bluetooth Smart frequency	2.4	2.445	2.483	Ghz

Power Consumption Note 1

	Min	Max	Unit
Reader		150	mA
Reader+Keyboard		250	mA

Note 1: Installer must take this data into account to dimension the CU42xx power supply. Readers only for use with the SALTO Control Units.

Note 2: Not use with Scotchlok butt connector UY2. SALTO recommends to use one cable per wall reader.

Cable type and max. distances

Cable type	Reader	Reader + keypad
UTP Cat5e 2 pairs AWG24	328ft	196ft
	100m	60m
UTP Cat5e 4 pairs AWG24 + SP224861/SP224895	820ft	492ft
	250m	150m
Twisted pairs AWG18 <small>Note 2</small>	1312ft	918m
	400m	280m

Note: UL tested at 24 AWG at 100m.

E Características eléctricas

Condiciones ambientales

	Min.	Max.	Unidad
Temperatura WRDOB - WRDOBK	-35	+66	°C
Temperatura WRDOJ - WRDOGK - WRDOJK	-25	+66	°C
Humedad	35	85	%

Características RF

	Min	Gen.	Max	Unit
Frecuencia RFID		13.56		Mhz
Frecuencia Bluetooth Smart	2.4	2.445	2.483	Ghz

Consumo Nota 1

	Min	Max	Unit
Lector		150	mA
Lector + teclado		250	mA

Nota 1: El instalador ha de tener en cuenta la dimensión del alimentador de la CU42xx
Nota 2: No usar el conector Scotchlok butt UY2 con este tipo de cable
SALTO recomienda utilizar un cable por cada lector mural.

Tipo de cable y distancias max.

Tipo de cable	Lector	Lector + Teclado
UTP Cat5e 2pares AWG24	100m	60m
UTP Cat5e 4 pares AWG24 + SP224861/SP224895	250m	150m
Pares trenzados AWG18 <small>Note 2</small>	400m	280m

D Elektronische Eigenschaften:

Umgebungsbedingungen

	Min.	Max.	Einheit
Temperatur WRDOB - WRDOBK	-35	+66	°C
Temperatur WRDOJ - WRDOGK - WRDOJK	-25	+66	°C
Feuchtigkeit	35	85	%

RF Frequenzen

	Min	Mitte	Max	Einheit
RFID Frequenz		13.56		Mhz
Bluetooth Smart Frequenz	2.4	2.445	2.483	Ghz

Stromaufnahme Note 1

	Min	Max	Einheit
Leser		150	mA
Leser+Keypad		250	mA

Note 1: Bitte beachten Sie die Stromaufnahme bei der Planung des Netzteils für die CU42XX
Note 2: Nicht verwenden mit den Scotchlok Einzeladerverbinder UY2
SALTO empfiehlt die Verwendung einer separaten Leitung je Wandleser.

Verkabelung und max. Entfernungen

Kabeltyp	Leser	Leser + Keypad
UTP Cat5e 2Paar AWG24	100m	60m
UTP Cat5e 4 Paar AWG24 + SP224861/SP224895	250m	150m
Twisted-pair AWG18 <small>Note 2</small>	400m	280m

F Caractéristique électronique

Condition de fonctionnement

	Min.	Max.	Unité
Température WRDOB - WRDOBK	-35	+66	°C
Température WRDOJ - WRDOGK - WRDOJK	-25	+66	°C
Humidité	35	85	%

Caractéristiques RF

	Min	Gen.	Max	Unité
Fréquence RFID		13.56		Mhz
Fréquence Bluetooth Smart	2.4	2.445	2.483	Ghz

Consommation Note 1

	Min	Max	Unité
Lecteur		150	mA
Lecteur + Clavier		250	mA

Note 1: l'installateur doit calculer l'alimentation nécessaire pour alimenter la CU42xx.
Note 2: Ne pas utiliser le connecteur Scotchlok UY2 avec ce type de câble
SALTO recommande d'utiliser un câble pour chaque lecteur mural

Type de câble

Type de câble	Lecteur	Lecteur + Clavier
UTP Cat5e 2 paires AWG24	100m	60m
UTP Cat5e 4 paires AWG24 + SP224861/SP224895	250m	150m
Paire torsadée AWG18 <small>Note 2</small>	400m	280m

NL Technische gegevens:

Omgeving

	Min.	Max.	Unit
Temperatuur WRDOB - WRDOBK	-35	+66	°C
Temperatuur WRDOJ - WRDOGK - WRDOJK	-25	+66	°C
Vochtigheid	35	85	%

RF karakteristieken

	Min	Gen.	Max	Unit
RFID frequency		13.56		Mhz
Bluetooth Smart frequency	2.4	2.445	2.483	Ghz

Voeding in opm 1

	Min	Max	Unit
Wandlezor		150	mA
Wandlezor+Keyboard		250	mA

Opm. 1: Installateur moet deze info meenemen voor de berekening van de voeding voor de CU42xx
Opm. 2: 3M Scotchlok 2-voudig draad connectors NIET GEBRUIKEN !!!
SALTO adviseert enkel één kabel per wandlezor te gebruiken.

Vermogen en max. afstand

Kable type	Wandlezor	Wandlezor + Keypad
UTP Cat5e 2 pairs AWG24	100m	60m
UTP Cat5e 4 pairs AWG24 + SP224861/SP224895	250m	150m
Twisted pair AWG18 <small>opm 2</small>	400m	280m

SVE Teknisk data:

Arbetsområde

	Min.	Max.	Enhet
Temperature WRDOB - WRDOBK	-35	+66	°C
Temperature WRDOJ - WRDOGK - WRDOJK	-25	+66	°C
Fukt	35	85	%

RF data

	Min	Gen.	Max	Enhet
RFID Frekvens		13.56		Mhz
Bluetooth Smart Frekvens	2.4	2.445	2.483	Ghz

Strömkonsumtion Not 1

	Min	Max	Enhet
Läsare		150	mA
Läsare+Knappsats		250	mA

Not. 1: Installatör måste ta med denna information för att beräkna strömåtgång
Not. 2: Ej med Scotchlock butt UY2 kontakt
SALTO rekommenderar att en kabel per väggläsare används.

Kabeltyper och max avstånd

Kabel	Läsare	Läsare + Knappsats
UTP Cat5e 2 pairs AWG24	100m	60m
UTP Cat5e 4 pairs AWG24 + SP224861/SP224895	250m	150m
Partvinnad AWG18 <small>Not 2</small>	400m	280m

Installation guide

XS4 Reader

- Ⓔ **Installation example:**
- Ⓔ *Ejemplo de instalación:*
- Ⓔ *Installationsbeispiel:*
- Ⓔ *Exemple d'installation:*
- Ⓔ *Installatievoorbeeld:*
- Ⓔ *Installationsexempel:*

- Ⓔ **Only connect to CU42xx**
- Ⓔ *Solo conectar a CU42xx*
- Ⓔ *Nur für Steuereinheit CU42xx*
- Ⓔ *Connecter uniquement CU42xx*
- Ⓔ *Alleen aansluiten aan CU42xx*
- Ⓔ *Ansluts endast till CU42xx*

- Ⓔ **Cable connection**
- Ⓔ *Câblage*
- Ⓔ *Cableado*
- Ⓔ *Draadwerk*
- Ⓔ *Verdrahtung*
- Ⓔ *Ledningar*

	Eng	Esp	Fra	Deu	Ned	Sve
B	Green	Verde	Vert	Grün	Groen	Grön
A	Yellow	Amarillo	Jaune	Gelb	Geel	Gul
⊥	Black	Negro	Noir	Schwarz	Zwart	Svart
+V	Red	Rojo	Rouge	Rot	Rood	Röd

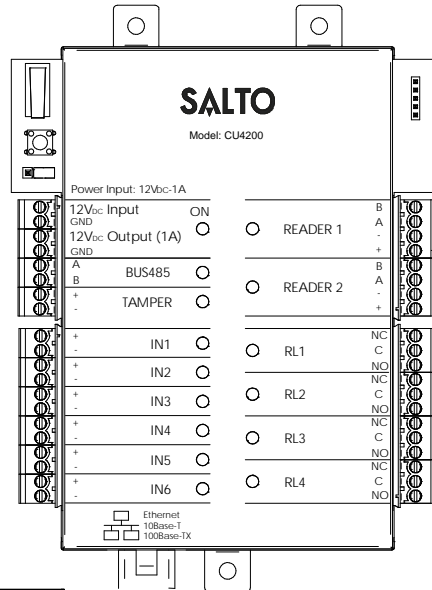

- Ⓔ **Same pair**
- Ⓔ *Même paire*
- Ⓔ *Mismo par*
- Ⓔ *Gleiches Paar*
- Ⓔ *Hetzelfde paar*
- Ⓔ *Samma par*

- Ⓔ **3M™ Scotchlok™ butt connector UY2. Crimp with cap side down.**
- Ⓔ *Conector 3M™ Scotchlok™ butt UY2. Crimpar con la tapa hacia abajo.*
- Ⓔ *3M™ Scotchlok™ butt Einzeladerverbinder UY2. Mit der Kappe nach unten zusammendrücken.*
- Ⓔ *Connecteur 3M™ Scotchlok™ butt UY2. Crêper avec le capuchon vers le bas.*
- Ⓔ *3M™ Scotchlok™ draad connectors - UY2. Krimp/aanknijpen met het gekleurde deksel naar beneden.*
- Ⓔ *3M™ kontakt Scotchlok™ butt UY2. Monteras med platta sidan neråt.*

- Ⓔ **Installation example with RJ45:**
- Ⓔ *Ejemplo de instalación RJ45:*
- Ⓔ *Innstillationsbeispiel für RJ45:*

- Ⓔ *Exemple d'installation avec connecteur RJ45 :*
- Ⓔ *Installatie voorbeeld RJ45:*
- Ⓔ *Installationsexempel RJ45:*

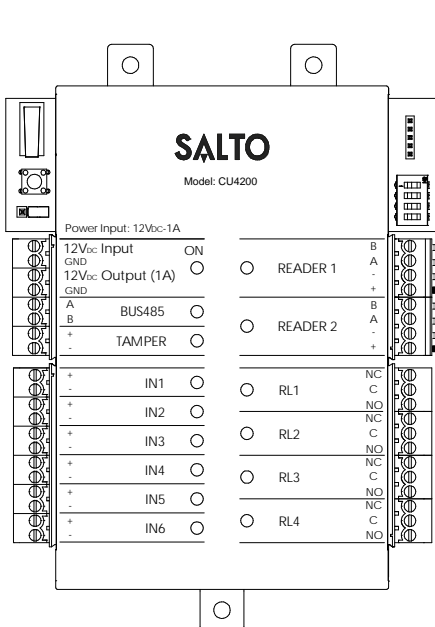

- Ⓔ **Optional**
- Ⓔ *Opcional*
- Ⓔ *Optioneel*
- Ⓔ *Optionnelle*
- Ⓔ *Facultatief*
- Ⓔ *Valfritt*

- Ⓔ **Optional**
- Ⓔ *Opcional*
- Ⓔ *Optioneel*
- Ⓔ *Optionnelle*
- Ⓔ *Facultatief*
- Ⓔ *Valfritt*

- Ⓔ **Black**
- Ⓔ *Negro*
- Ⓔ *Schwarz*
- Ⓔ *Noir*
- Ⓔ *Zwart*
- Ⓔ *Svart*

- Ⓔ **Red**
- Ⓔ *Rojo*
- Ⓔ *Rot*
- Ⓔ *Rouge*
- Ⓔ *Rood*
- Ⓔ *Röd*

- Ⓔ **Minimum distance between readers 20in (50cm).**
- Ⓔ *Distancia mínima entre los lectores 20in (50cm).*
- Ⓔ *Mindestabstand zwischen Lesern 20in (50cm).*
- Ⓔ *Distance minimale entre les lecteurs doit être de 20in (50cm).*
- Ⓔ *Minimale afstand tussen de lezers 20in (50cm).*
- Ⓔ *Minsta avstånd mellan läsare 20in (50cm).*

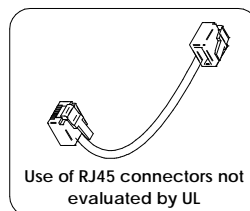

Installation guide

XS4 Reader

Eng SIGNALLING

Signal	Light	Time (sec)	Buzzer	Time (sec)
Card Rejection	Red	1	High pitched 50/50	1
Privacy or emergency status	Red 5x(50/50x3+off300)	3	High pitched 5x(50/50x3 + off 300)	3
Standard opening	Green	1	Low pitched	0,3
Standard locking	Red	0,5	Low pitched	0,2
Open plus office	Green 400/200	2,4	High pitched/Low pitched 400/200	2,4
CLR Button	Orange	Cont.	High pitched	Cont.
Reset	Orange 50/100	450 msg	Low pitched 50/100	450 msg

E SEÑALÉCTICA

Señal	Luz	Tiempo (seg)	Buzzer	Tiempo (seg)
Rechazo de Tarjeta	Rojo	1	Agudo 50/50	1
Rechazo por Privacidad o Emergencia	Rojo 5x(50/50x3+ apagado 300)	3	Agudo 5x(50/50x3 + apagado 300)	3
Apertura Normal	Verde	1	Medio	0,3
Cierre Normal	Rojo	0,5	Grave	0,2
Abrir y Paso	Verde 400/200	2,4	Agudo/Grave 400/200	2,4
Botón CLR (3)	Naranja	Cont.	Agudo	Cont.
Reset	Naranja 50/100	450 msg	Medio 50/100	450 msg

D SIGNALE

Signal	LED	Zeit (Sek)	Buzzer	Zeit (Sek)
Karte abgelehnt	Rot	1	Hoher Ton 50/50	1
Bitte-nicht-stören oder Notschließung	Rot 5x(50/50x3+ aus300)	3	Hoher Ton 5x(50/50x3 + aus 300)	3
Normale Türöffnung	Grün	1	Tiefer Ton	0,3
Verschluss der Tür	Rot	0,5	Tiefer Ton	0,2
Office-Mode aktiviert	Grün 400/200	2,4	Hoher Ton /Grave 400/200	2,4
CLR Taste gedrückt	Orange	Kont.	Hoher Ton	Kont.
Reset	Orange 50/100	450 msg	Tiefer Ton 50/100	450 msg

F SIGNALISATION

Signal	Voyant	Temps (sec)	Buzzer	Temps (sec)
Carte rejetée	Rouge	1	Aigu 50/50	1
Privacité ou état d'urgence	Rouge 5x(50/50x3+ off300)	3	Aigu 5x(50/50x3 + off 300)	3
Ouverture Standard	Vert	1	Grave	0,3
Verrouillage Standard	Rouge	0,5	Grave	0,2
Ouverture passage libre	Vert 400/200	2,4	Aigu/Grave 400/200	2,4
Bouton CLR	Orange	Cont.	Aigu	Cont.
Reset	Orange 50/100	450 msg	Grave 50/100	450 msg

NL SIGNALERING

Signaal	LED indicatie	Time (sec)	Geluid	Time (sec)
Geen rechten	Rood	1	Hoge tonen 50/50	1
Privacy- of noodsluiting	Rood 5x(50/50x3+ off 300)	3	Hoge tonen 5x(50/50x3 + off 300)	3
Standaard opening	Groen	1	Lage tonen	0,3
Standaard sluiting	Rood	0,5	Lage tonen	0,2
Open plus loopstand	Groen 400/200	2,4	Hoge tonen /Grave 400/200	2,4
CLR knop	Oransje	Cont.	Hoge tonen	Cont.
Reset	Oransje 50/100	450 msg	Lage tonen 50/100	450 msg

SVE SIGNALERING

Händelse	Ljussignal	Tid (sek)	Summer	Tid (sek)
Nekat tillträde	Röd	1	Hög ton 50/50	1
Stör ej eller Nödläge	Röd 5x(50/50x3+ av 300)	3	Hög ton 5x(50/50x3 + av 300)	3
Standard öppning	Grön	1	Låg ton	0,3
Standard stängning	Röd	0,5	Låg ton	0,2
Öppning med kontorsfunktion	Grön 400/200	2,4	Hög ton 400/200	2,4
CLR Knapp	Orange	Konst.	Hög ton	Konst.
Nollställning	Orange 50/100	450 msg	Låg ton 50/100	450 msg